

Article number: 0106064

Description: Retaining ring JV 47

Measures

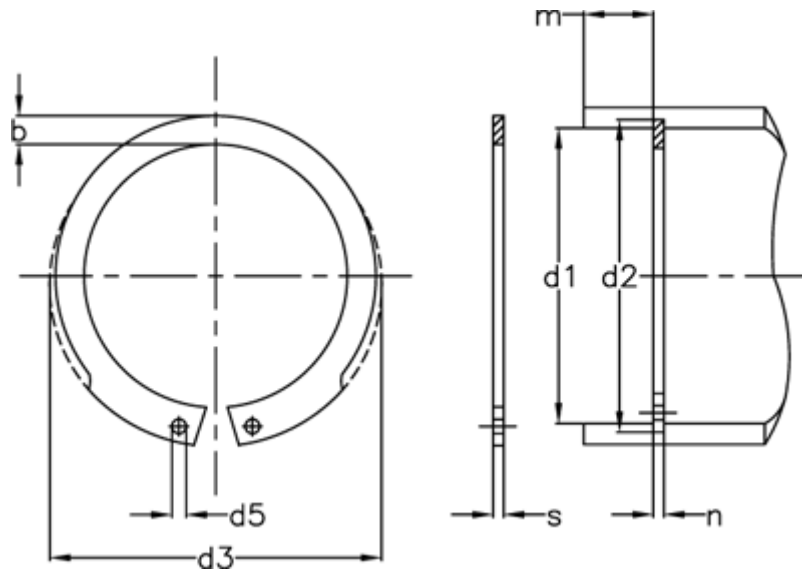

AN mm ²	= 95	FRg kN	= 8.7	tol	= 0.2
b	= 4.7	FR kN	= 45.0	tol	= -0.06
d1	= 47	g	= 2.0	tol	= +1,10-0,46
d2	= 49.5	K kN-mm	= 81.3	tol	= +0,25
d3	= 50.5	m min	= 1.85	Tong	= ZGJ-2
d5 min	= 2.0	Nominal drive	= 3.8	Weight kg/1000	= 6.50
Description	= JV 47	s	= 1.75		
FN kN	= 15.80	t	= 1.25		